

Kit Includes	Qty
Base Shoe: 10'	1
Cladding: 10'	2
End Caps	2
Joining Pins	4
Glass Spacers: 4"	1
Stabilizing Washers	10

Choice of different glass thickness.

- 8 grips
- 2 gaskets

Glass Kit No.	Glass Thickness
SSSM5GLASS1	19 to 21,52 mm
SSSM5GLASS2	24,76 to 26,52 mm

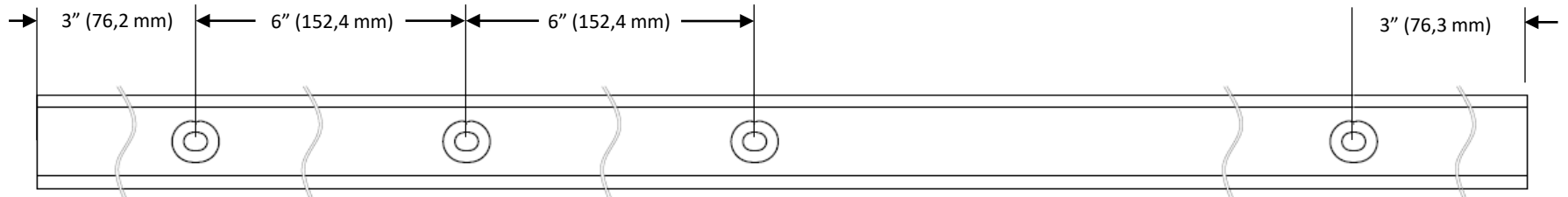
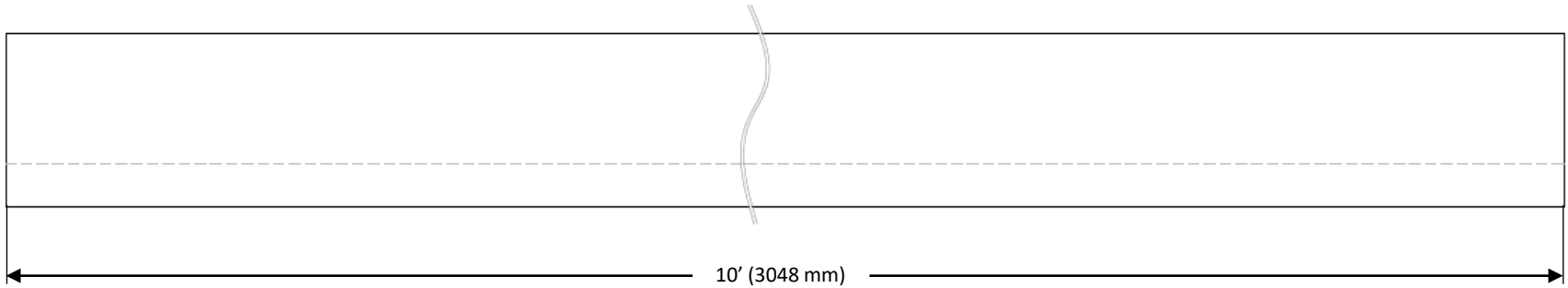

HOLE DETAIL

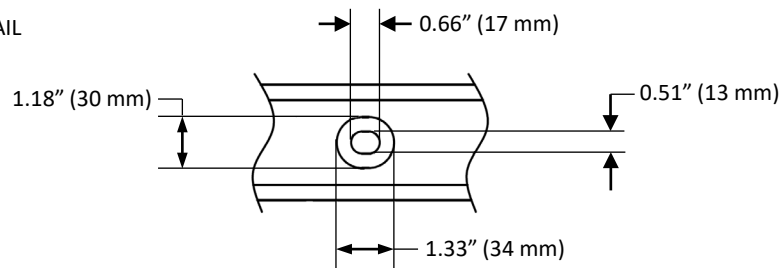

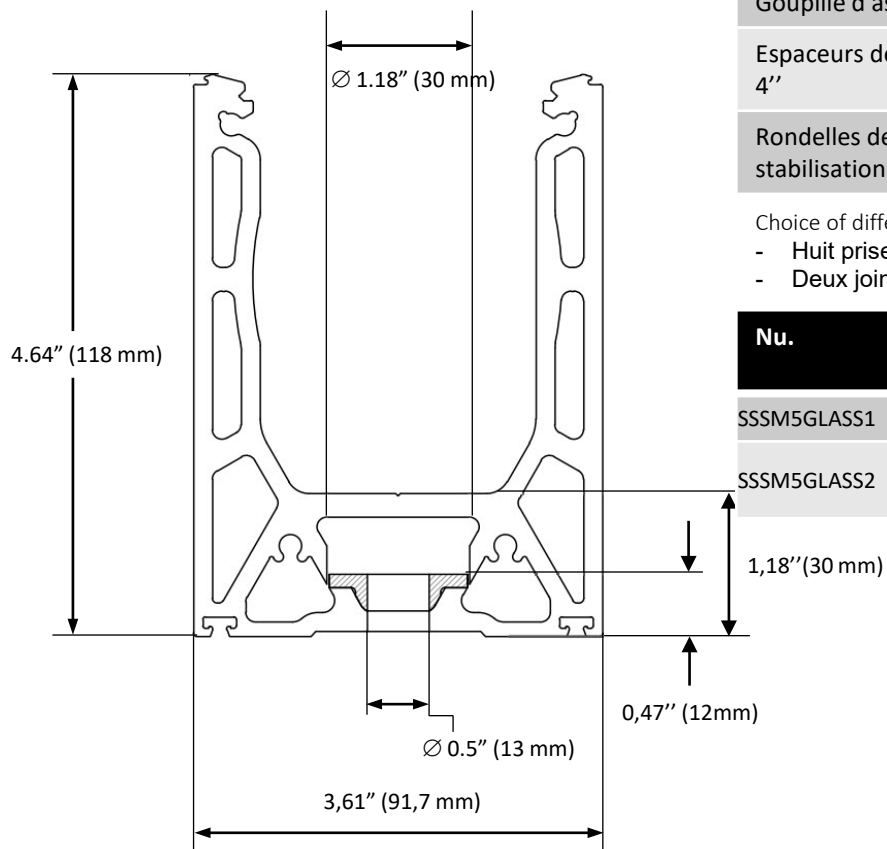
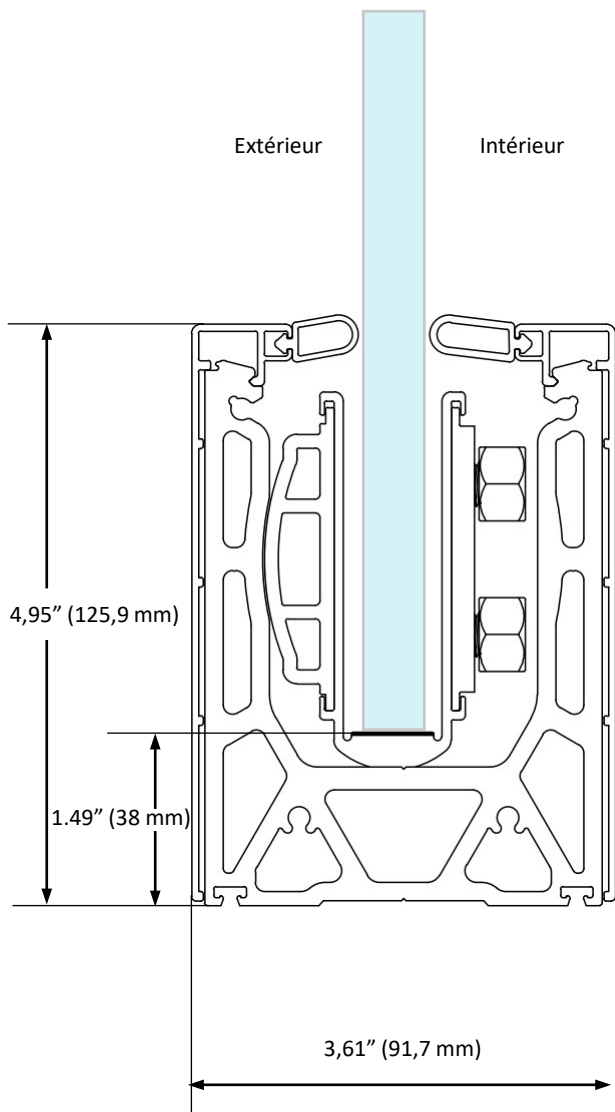

Inclus	Qté
Sabot: 10'	1
Embouts	2
Goupille d'assemblage	4
Espaceurs de verre : 4"	1
Rondelles de stabilisation	10

Choice of different glass thickness.

- Huit prises
- Deux joints d'étanchéité

Nu.	Épaisseur du verre
SSSM5GLASS1	19 to 21,52 mm
SSSM5GLASS2	24,76 to 26,52 mm

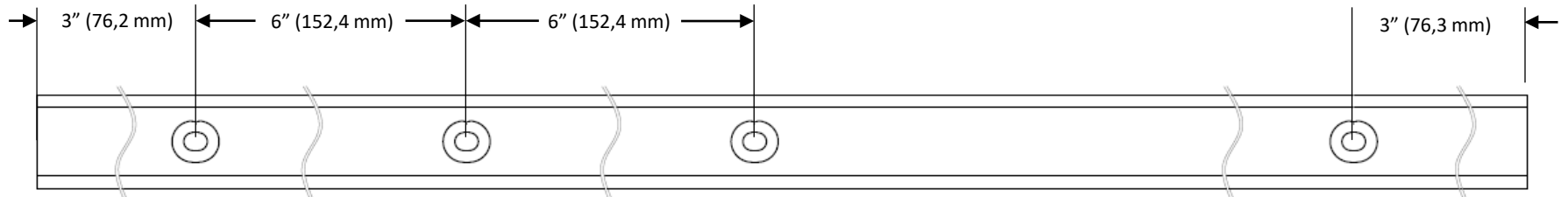
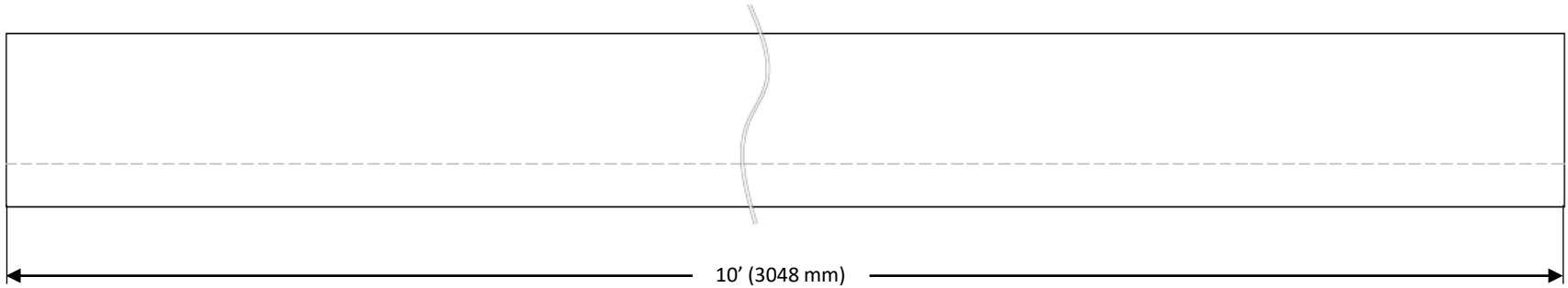

Détail des trous

