

Sqaure Ladder Handle

Code	Material	H	C/C
701DH153260xxx	SS316 + wood	(60") 1524 mm	(48") 1219 mm

► Measurements

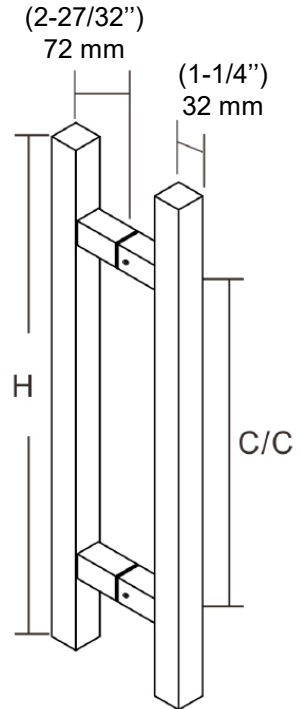
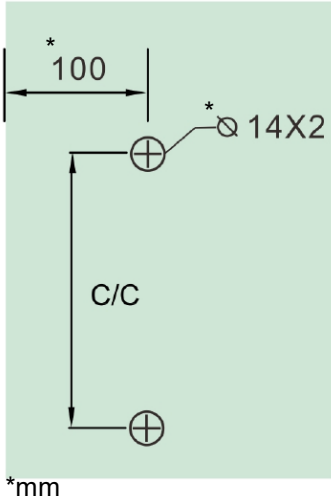

► Components

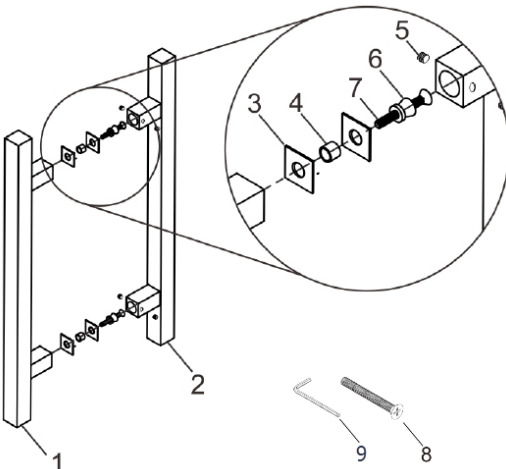

#	Name	Qty
1	Exterior Handle	1
2	Interior Handle	1
3	Gasket	4
4	Plastic Washer	2
5	Set Screw M6x5mm	4
6	Collar	2
7	Screw M8x45mm	2
8	Screw M8x80mm	2
9	Allen Key 3mm	1

Square Ladder Handle

► Installation

Install the exterior handle as shown with one gasket and metal washer on each side of the glass.

- *Philips screwdriver not included
- *Use the 45mm screw for glass doors 8-12mm thick
- *Use the 80mm screw for wood doors 35-50mm thick

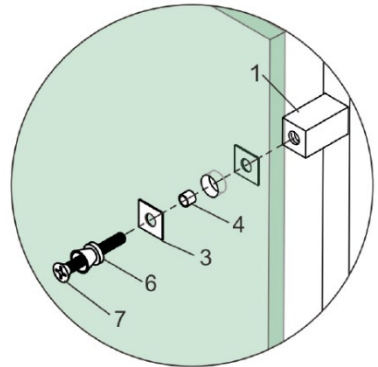

Install the interior handle onto the collars.

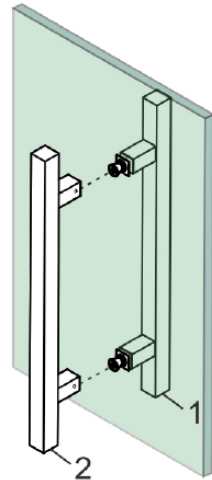

Install the set screws and tighten with the Allen key to finish the installation

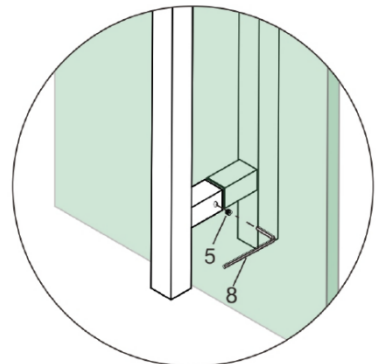

Poignée échelle carrée

Code	Matériel	H	C/C
701DH153260xxx	SS316 + wood	(60") 1524 mm	(48") 1219 mm

► Dimensions

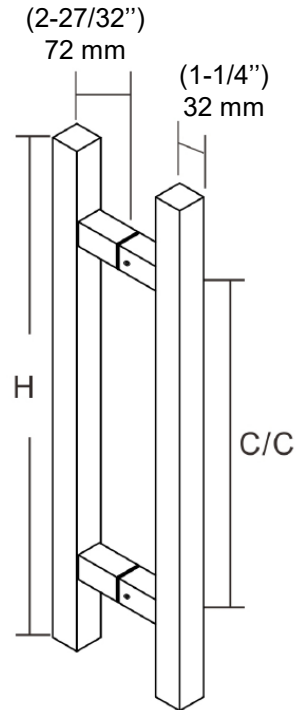
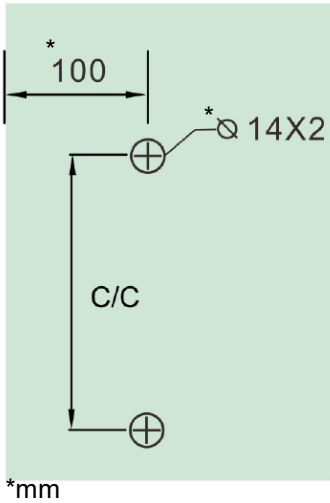

► Composantes

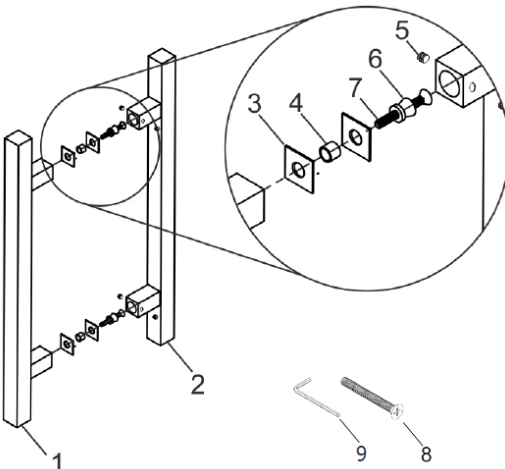

#	Nom	Qté
1	Poignée extérieure	1
2	Poignée intérieure	1
3	Joint	4
4	Rondelles en plastique	2
5	Vis M6x5mm	4
6	Collier	2
7	Vis M8x45mm	2
8	Vis M8x80mm	2
9	Clé Allen 3mm	1

Poignée échelle carrée

► Installation

Installez la poignée extérieure comme illustré avec un joint et une rondelle métallique de chaque côté du verre.

*Tournevis Philips non inclus

*Utilisez la vis de 45 mm pour les portes en verre de 8-12 mm

*Utilisez la vis de 80 mm pour les portes en bois de 35-50 mm

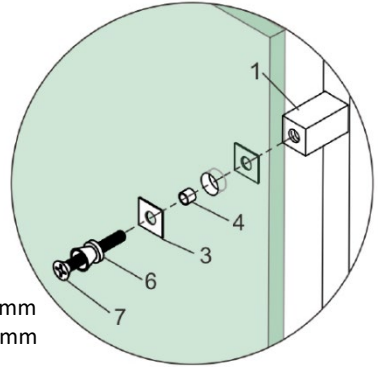

Installez la poignée intérieure sur les colliers.

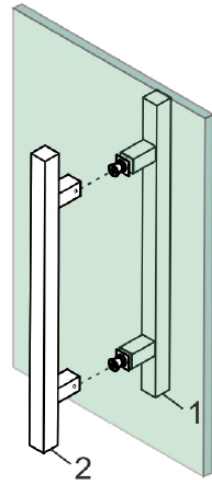

Installez les vis de réglage et serrez avec la clé Allen pour terminer l'installation

