

Round Ladder Handle

Code	Material	H	C/C
87H2R196xxx	SS304	(6") 152 mm	(10") 254 mm

Measurements

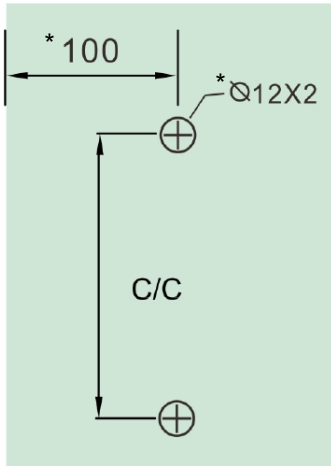

*mm

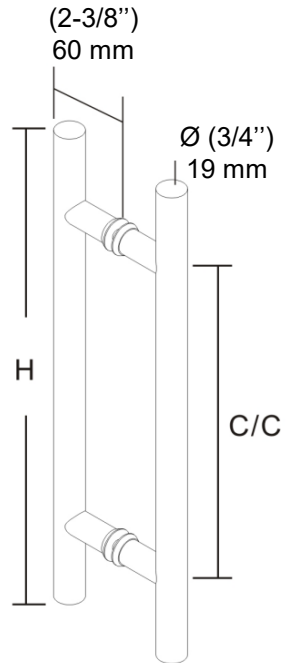

Components

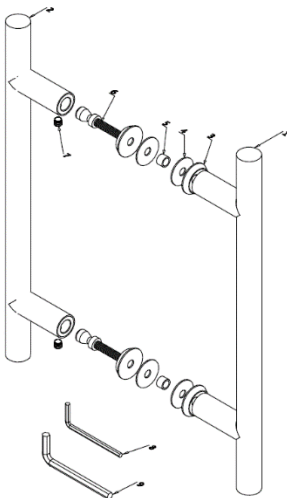

#	Name	Qty
1	Exterior Handle	1
2	Interior Handle	1
3	Metal Washer	4
4	Gasket	4
5	Plastic Washer	4
6	Assembly Screw	2
7	Set Screw	2
8	Allen Key 3mm	1
9	Allen Key 5 mm	1

Round Ladder Handle

► Installation

Install the exterior handle as shown with one gasket and metal washer on each side of the glass.

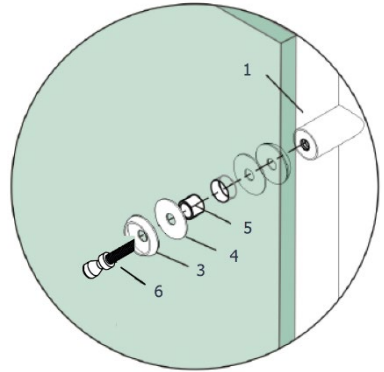

Install the interior handle onto the screws.

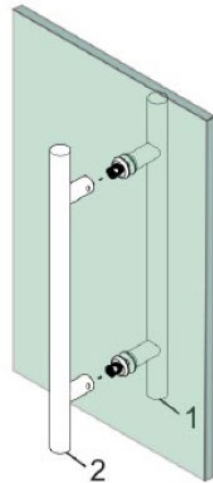

Install the set screws and tighten with the Allen key to finish the installation

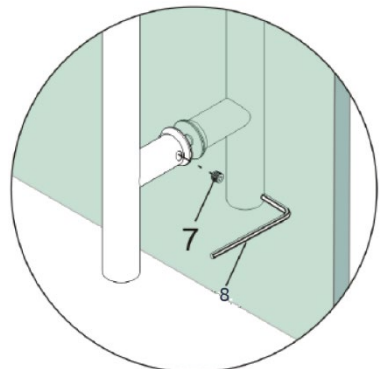

Poignée échelle ronde

Code	Matériel	H	C/C
87H2R196xxx	SS304	(6") 152 mm	(10") 254 mm

► Dimensions

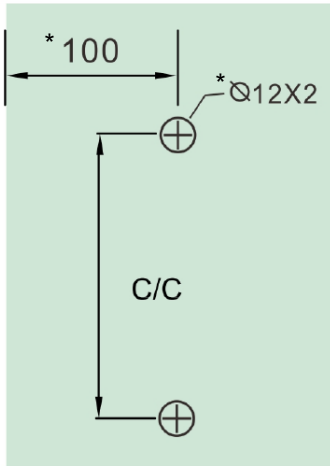

*mm

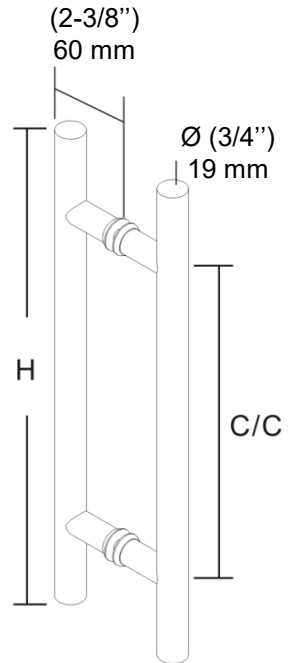

► Composantes

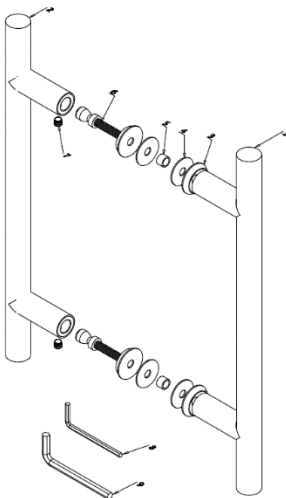

#	Nom	Qté
1	Poignée extérieure	1
2	Poignée intérieure	1
3	Rondelle en métal	4
4	Joint	4
5	Rondelle en plastique	4
6	Vis d'assemblage	2
7	Vis	2
8	Clé Allen 3mm	1
9	Clé Allen 5 mm	1

Poignée échelle ronde

► Installation

Installez la poignée extérieure comme illustré avec un joint et une rondelle métallique de chaque côté du verre.

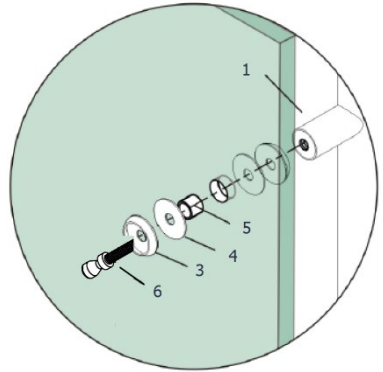

Installez la poignée intérieure sur les vis.

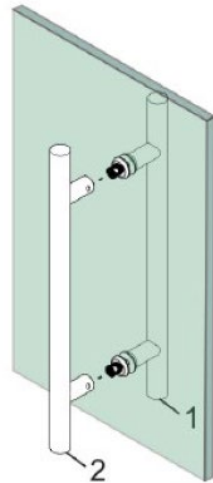

Installez les vis de réglage et serrez avec la clé Allen pour terminer l'installation

