

Combination Handle and Towel Bar

Code	Material	C/C 1	C/C 2
8702S100618xxx	SS304	(6") 152 mm	(18") 457 mm

Measurements

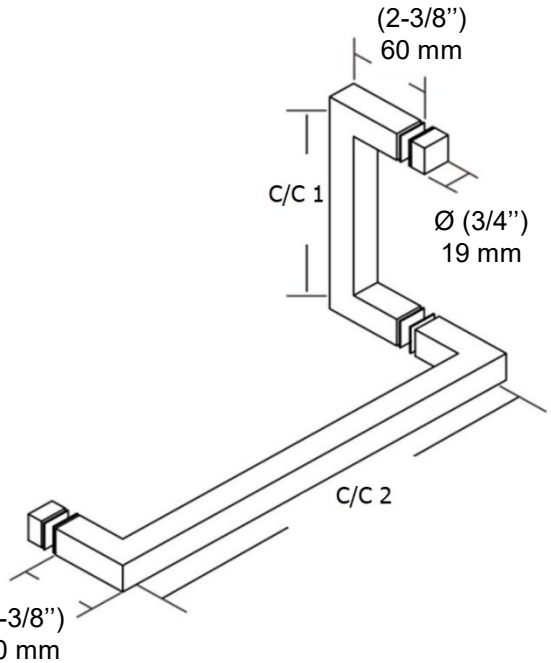
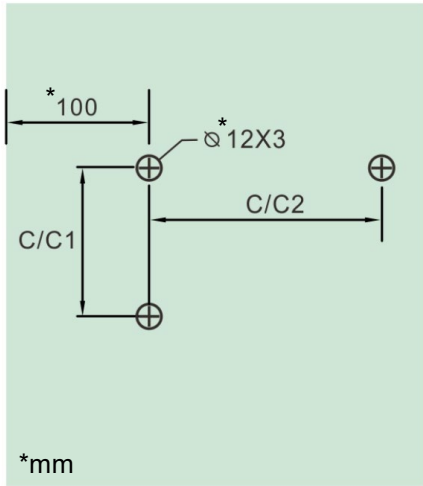

Components

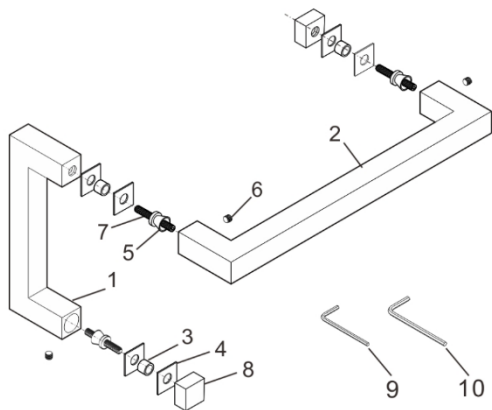

#	Name	Qty
1	Handle	1
2	Towel Bar	1
3	Plastic Washer	3
4	Gasket	6
5	Collar	3
6	Set Screw M5x5mm	3
7	Screw M6x35mm	3
8	Knob	2
9	Allen Key 2.5mm	1
10	Allen Key 3mm	1

Combination Handle and Towel Bar

► Installation

Use the 3mm Allen Key to install the handle as shown with a gasket on each side of the glass.

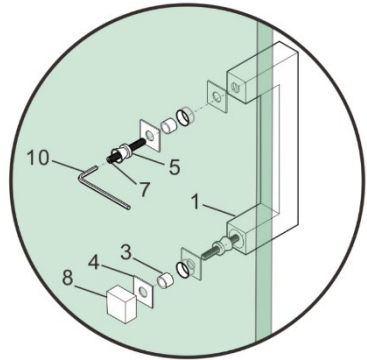

Install the second knob and then install the towel bar onto the two collars.

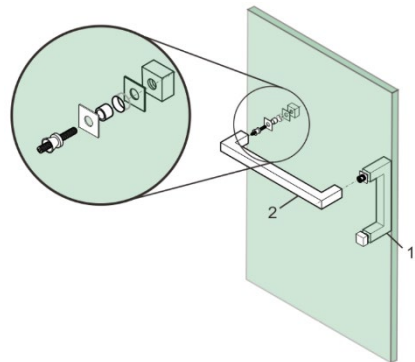

Install the set screws (9) and tighten with the Allen key to finish the installation.

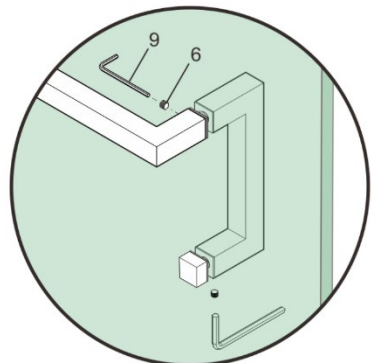

Combinaison poignée et porte-serviettes

Code	Matériel	C/C 1	C/C 2
8702S100618xxx	SS304	(6") 152 mm	(18") 457 mm

► Dimensions

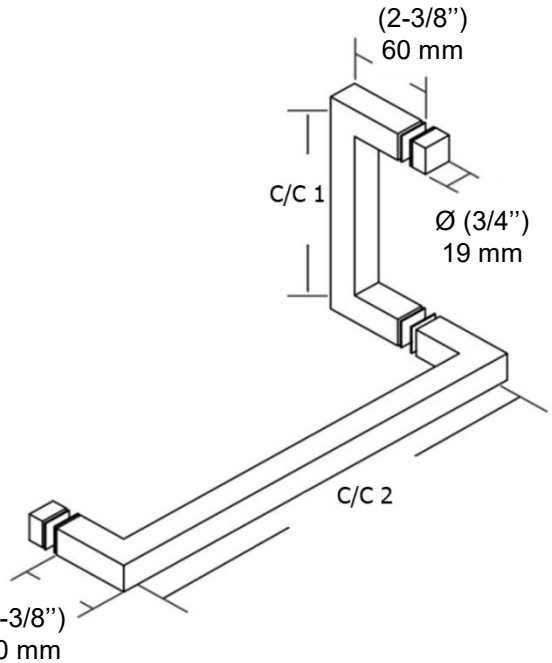
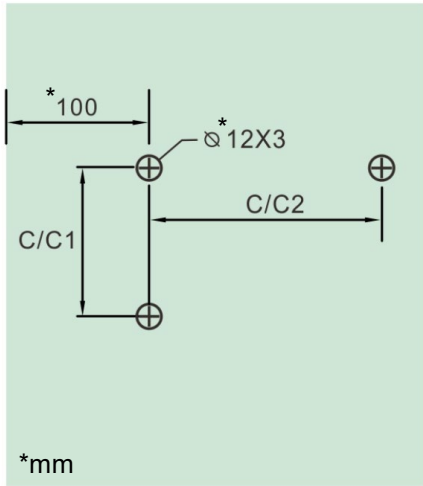

► Composantes

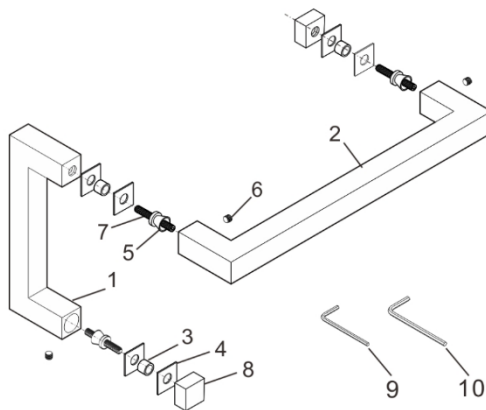

#	Nom	Qté
1	Poignée	1
2	Porte-serviette	1
3	Rondelles plastique	3
4	Joints	6
5	Collier	3
6	Vis M5x5mm	3
7	Vis M6x35mm	3
8	Bouton	2
9	Clé Allen 2.5mm	1
10	Clé Allen 3mm	1

Combinaison poignée et porte-serviettes

► Installation

Utilisez la clé Allen de 3 mm pour installer la poignée comme indiqué, avec un joint de chaque côté du verre.

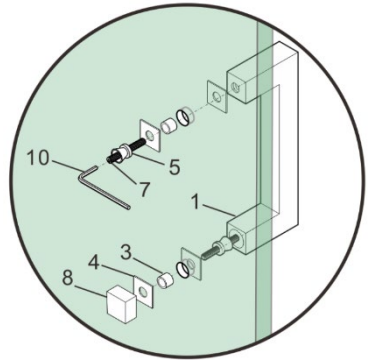

Installez le deuxième bouton, puis installez le porte-serviettes sur les deux colliers.

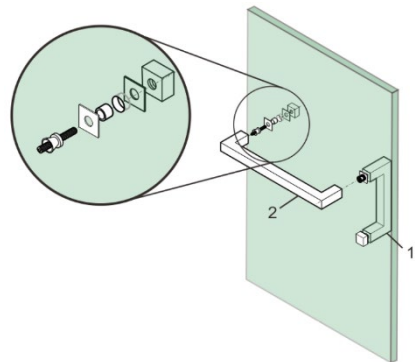

Installez les vis de réglage et serrez-les avec la clé Allen pour terminer l'installation.

