

180° Glass Connector Square

Model	Material	Glass Thickness
HRGCS6536180170	SS 316	10/12mm

- * 12mm gaskets included, other gasket sizes sold separately
- * Glass drilling optional
- * Optional safety lockpin included

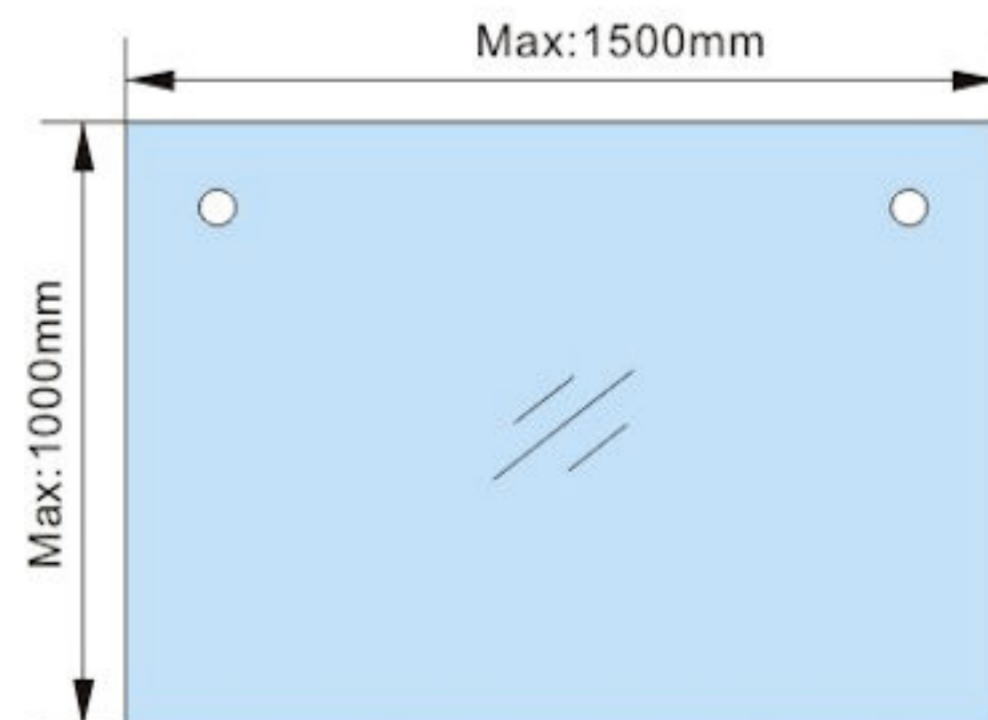
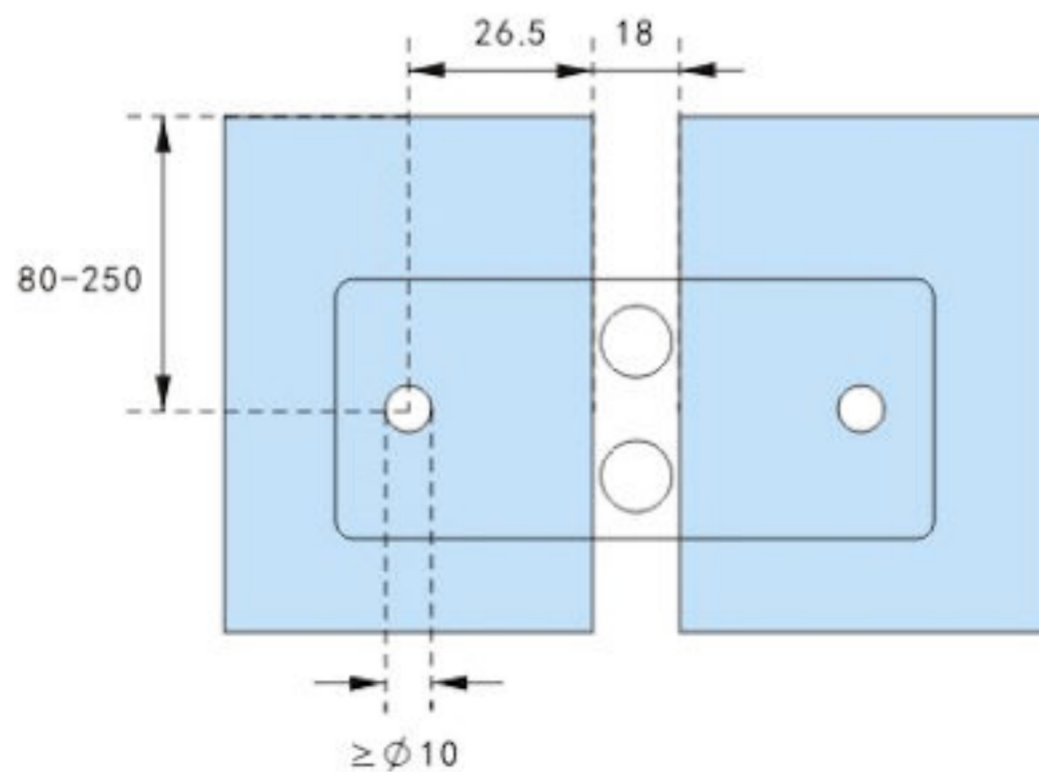
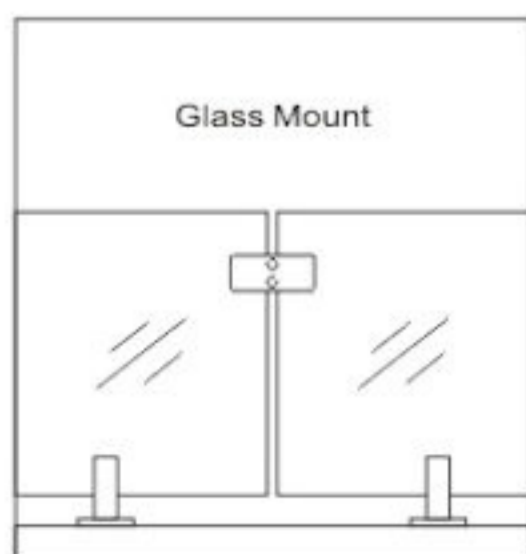
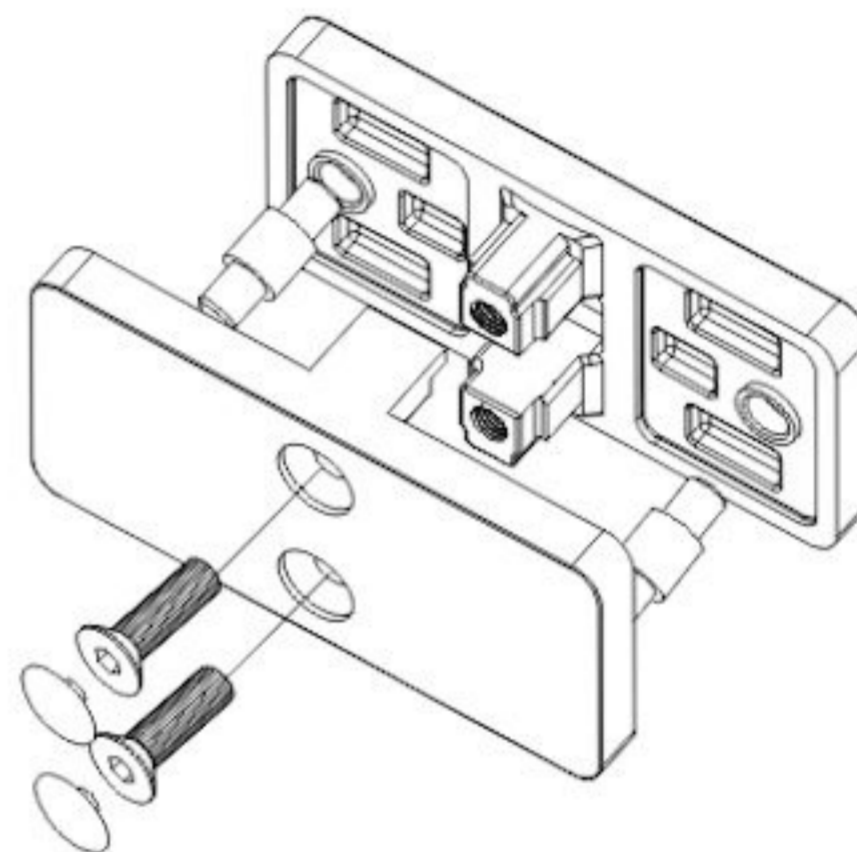

Raccord de 180° pour verre Carré

Modèle	Matériel	Épaisseur de verre
HRGCS6536180170	Al 316	10/12mm

- * Joints pour verre de 12mm inclus, autres épaisseurs vendus séparément
- * Perçage du verre optionnelle (non-requis)
- * Goupille de sécurité pour verre percé inclus

